



# ADT681 DIGITAL PRESSURE GAUGE

# **ADT681 DIGITAL PRESSURE GAUGE**

## ————— **User Manual**

[Version:1705V19]

Please download the latest version via [www.additel.com](http://www.additel.com)

**CE ATEX**  **DNV**

**Additel Corporation**

---

# CONTENTS

<b>1. Introduction</b>	<b>1</b>
<b>2. Specifications</b>	<b>2</b>
<b>3. Instructions for use</b>	<b>5</b>
<b>4. Basic structure</b>	<b>7</b>
<b>5. Keypad function</b>	<b>8</b>
<b>6. Display function</b>	<b>9</b>
<b>7. Basic operation</b>	<b>11</b>
7.1 Power on/off	11
7.2 Pressure measure	12
7.3 Zeroing	13
7.4 Pressure units	15
7.5 Peak detection	16
7.6 Backlight	17
7.7 Analog dial	17
7.7.1 Percent pressure	18
7.7.2 Pressure swing	18
7.7.3 Overpressure alarm	18
7.7.4 Setting alarm limit	19
7.8 Temperature measure	20
7.9 Data logging (optional)	21
7.9.1 Save menu	21
7.9.2 To log data	21
7.9.3 Export data via Additel/Land software	22
7.10 Factory Menu	26
<b>8. Menu operation</b>	<b>28</b>
8.1 Enter the Menu	28

8.2 Menu option	29
8.3 Enter/cancel the calibration	30
8.4 To cancel the previous zeroing	30
8.5 To set measure speed	30
8.6 To set filtering effectively	30
8.7 Set RS232 address	30
8.8 To set the RS232 baud rate	30
8.9 To set the automatic shutdown	31
8.10 To set the 4 or 5 digit display	31
8.11 Set custom unit factor	31
8.12 Set tare function	31
8.13 Set single-point calibration	31
<b>9. Calibration function</b>	<b>32</b>
9.1 Calibration conditions	32
9.2 Calibration process	32
9.3 Cancel calibration	34
<b>10. Power supply description</b>	<b>34</b>
<b>11. Measure speed and Working time</b>	<b>36</b>
<b>12. Accessories</b>	<b>37</b>
<b>13. Contact us</b>	<b>37</b>
<b>Appendix I: Communication protocols</b>	<b>38</b>
1. Instructions format	38
2. Instructions details	40
3. Pressure units abbreviations	42
4. Pressure units code	42
5. Data automatically transmit format	42

## 1. Introduction

The ADT681 is designed to offer a truly compact, cost effective digital pressure gauge to cover a wide range of applications. Along with its pressure measuring functions, it can be used as a calibration standard for calibration of standard pressure gauges, precision pressure gauges, industry pressure gauges, blood pressure meters and other pressure instruments.

The ADT681 digital pressure gauge uses a 9V battery (ANSI/NEDA 1604A or IEC 6LR61) or a special DC9V adapter power supply.

The ADT681 digital pressure gauge is electromagnetic compatibility (EMC) tested to be used in a variety of electromagnetic environments. In addition, it is certified by European CE standard.

The ADT681 digital pressure gauge has two types: the standard type and the intrinsically safe type (ADT681IS). The ADT681IS includes the following intrinsic safety approvals:



ATEX

⊕ Ex II 1 G Ex ia IIC T4 Ga

Permitted for zone 0, Equipment Group II, Gas Group IIC hazardous atmospheres, temperature class T4

This product conforms to the following standards: • EN 60079-0:2009 • EN 60079-11:2007



Ex ia IIC T4

Class I, Zone 0, DIV1

Groups A, B, C and D

Ta= -10°C to + 50 °C

The Additel 681 has the optional data logging function.



## 2. Specifications

### ◆ Pressure ranges

Gauge Pressure <sup>(1)</sup>					
P/N	Pressure Range(psi)	Pressure Range(bar)	Media	Accuracy(%FS)	Burst Pressure
V15	-15	-1	G	0.02 (0.05, 0.1, 0.2)	3X
GP2	2	0.16	G	0.05 (0.1, 0.2)	3X
GP5	5	0.35	G	0.02 (0.05, 0.1, 0.2)	3X
GP10	10	0.7	G	0.02 (0.05, 0.1, 0.2)	3X
GP15	15	1	G, L <sup>(2)</sup>	0.02 (0.05, 0.1, 0.2)	3X
GP30	30	2	G, L <sup>(2)</sup>	0.02 (0.05, 0.1, 0.2)	3X
GP50	50	3.5	G, L	0.02 (0.05, 0.1, 0.2)	3X
GP100	100	7	G, L	0.02 (0.05, 0.1, 0.2)	3X
GP300	300	20	G, L	0.02 (0.05, 0.1, 0.2)	3X
GP500	500	35	G, L	0.02 (0.05, 0.1, 0.2)	3X
GP600	600	40	G, L	0.02 (0.05, 0.1, 0.2)	3X
GP1K	1,000	70	G, L	0.02 (0.05, 0.1, 0.2)	3X
GP2K	2,000	140	G, L	0.02 (0.05, 0.1, 0.2)	3X
GP3K	3,000	200	G, L	0.02 (0.05, 0.1, 0.2)	3X
GP5K	5,000	350	G, L	0.02 (0.05, 0.1, 0.2)	3X
GP10K	10,000	700	G, L	0.02 (0.05, 0.1, 0.2)	2X
GP15K	15,000	1,000	G, L	0.05 (0.1, 0.2)	2X
GP20K	20,000	1,400	G, L	0.1 (0.2)	1.5X
GP25K	25,000	1,600	G, L	0.1 (0.2)	1.5X
GP30K	30,000	2,000	G, L	0.1 (0.2)	1.5X
GP36K	36,000	2,500	G, L	0.1 (0.2)	1.5X
GP40K	40,000	2,800	G, L	0.1 (0.2)	1.1X

Compound Pressure					
P/N	Pressure Range(psi)	Pressure Range(bar)	Media	Accuracy(%FS)	Burst Pressure
CP2	± 2	± 0.16	G	0.05 (0.1, 0.2)	3X
CP5	± 5	± 0.35	G	0.02 (0.05, 0.1, 0.2)	3X
CP10	± 10	± 0.7	G	0.02 (0.05, 0.1, 0.2)	3X
CP15	± 15	± 1	G	0.02 (0.05, 0.1, 0.2)	3X
CP30	-15 to 30	-1 to 2	G	0.02 (0.05, 0.1, 0.2)	3X
CP100	-15 to 100	-1 to 7	G, L	0.02 (0.05, 0.1, 0.2)	3X
CP300	-15 to 300	-1 to 20	G, L	0.02 (0.05, 0.1, 0.2)	3X

Absolute Pressure					
P/N	Pressure Range(psi)	Pressure Range(bar)	Media	Accuracy(%FS)	Burst Pressure
AP5	5	0.35	G	0.1 (0.2)	3X
AP10	10	0.7	G	0.1 (0.2)	3X
AP15	15	1.0	G	0.1 (0.2)	3X
AP30	30	2.0	G	0.1 (0.2)	3X
AP50	50	3.5	G	0.1 (0.2)	3X
AP100	100	7.0	G, L	0.05 (0.1, 0.2)	3X
AP300	300	20	G, L	0.05 (0.1, 0.2)	3X
AP500	500	35	G, L	0.05 (0.1, 0.2)	3X
AP1K	1,000	70	G, L	0.05 (0.1, 0.2)	3X
AP3K	3,000	200	G, L	0.05 (0.1, 0.2)	3X
AP5K	5,000	350	G, L	0.05 (0.1, 0.2)	3X

Differential pressure					
P/N	Pressure Range(inH <sub>2</sub> O)	Pressure Range(mbar)	Media	Accuracy(%FS)	Burst Pressure
DP1	± 1	± 2.5	G	0.05 <sup>(3)</sup>	100X
DP2	± 2	± 5.0	G	0.05 <sup>(3)</sup>	100X
DP5	± 5	± 10	G	0.05	50X
DP10	± 10	± 25	G	0.05	20X
DP20	± 20	± 50	G	0.05	20X
DP30	± 30	± 75	G	0.05	20X
DP50	± 50	± 160	G	0.05	3X
DP150	± 150	± 350	G	0.02 (0.05)	3X
DP300	± 300	± 700	G	0.02 (0.05)	3X

**Remark: G=Gas, L=Liquid, V=high pressure vapor**

Note: (1) Sealed gauge pressure for above 1,000 psi

(2) 0.02% FS for gas media only

(3)\* One year accuracy (including yearly stability) except DP1 and DP2 range which is 0.05%FS calibration accuracy and 0.05%FS yearly stability.

- ▶ Negative pressure: (lower limit of measurement ~ 0), numeric area of lower limit of measurement: –1bar ~ 0bar.
- ▶ Compound pressure: (lower limit of measurement ~ upper limit of measurement), numeric area of lower limit of measurement: –1bar ~ 0bar. Numeric area of upper limit of measurement is: 0 ~ 6 bar...2,500bar.
- ◆ Instrument types: Standard and intrinsically safe.
- ◆ Pressure units: mmH<sub>2</sub>O@ 4°C, mmHg @ 0°C, inH<sub>2</sub>O@ 4°C, inHg @ 0°C, kgf/cm<sup>2</sup>, psi, kPa, MPa, Pa, mbar and bar, customized pressure units.
- ◆ Over Pressure: when the measured value of pressure is greater than 120% FS, the entire screen will flash as an alarm.
- ◆ Measuring speed: the measuring speed can be customized. The default is 3 readings per second.
- ◆ Working environment: a. Ambient temperature: (–10~50)°C.                      b. Relative humidity: <95%.  
c. Atmospheric pressure: (86~106)kPa.



- ◆ Temperature compensation: (-10~50)°C (guaranteed accuracy).
- ◆ Storage temperature: -20°C ~ 70°C.
- ◆ Display: FSTN LCD, white backlight, 5-digit display.
- ◆ Battery life: 600 consecutive hours when the measuring speed is 3 times/s, See Table 11-1 for details.  
If the battery voltage is too low, the 681 will automatically shut down prior to any accuracy degradation.
- ◆ Power:  $\triangle$  9V alkaline batteries (ANSI/NEDA 1604A or IEC 6LR61), battery type must be approved (see power instructions) for the intrinsically safe type and a 9V power adapter (GME G051T-090065-1 Input AC100-240V, 50/60Hz, 0.2A, output DC9V, 0.65A) can also be used for the basic type.
- ◆ Data logging (optional): The totaled record is 21,800, includes date and time, pressure and temperature. The logging interval range is from 1 second to 99,999 seconds, which can be set by user.
- ◆ Rated power: 60mW.
- ◆ Serial Communication: Baud rate: 2400/4800/9600, 8 data bits, 2 stop bits, Address: 1 ~ 112, Um=10VDC.
- ◆ Exterior dimensions: gauge outfit  $\phi$  112mm X 35mm (4.41 x 1.38 in), total length 178mm (7.01 in).
- ◆ Weight: 580g (1.28 lbs).
- ◆ Pressure connection: 1/4" NPT or 1/4" BSP (can be customized as per user's requirement).
- ◆ Additional functions: Temperature measurement: resolution  $\pm 0.1$ °C.
  - Peak recording: the maximum and minimum pressure values recorded.
  - Pressure percentage indication: the current pressure measurement as a percentage of the gauges full scale.
  - Pressure fluctuation indication: the degree of fluctuation between two consecutive measured values of pressure.
  - Pressure alarm threshold indication: the permutation of 3 pointers indicating whether the current pressure is higher than the alarm threshold.
- ◆ Remark: For optional data logging, the flashing icon “%” means data is being logged.

### 3. Instructions for use

- ✈ Provides battery under voltage indicator. If the ADT681IS automatically shuts down, please replace the battery.

Do not replace the battery in an area with hazardous explosives.

- ✦ Only use batteries that have passed Ex approval tests. The use of any other batteries will invalidate the Ex approval and may result in safety risks.
- ✦ Never open the instrument case, otherwise the Ex approval will be invalidated.
- ✦ It is strictly prohibited to connect RS232 communication cables in areas with explosives, Um=10VDC.
- ✦ Do not replace the components or casing, as such replacements may weaken the explosion-proof performance.
- ✦ When used in hazardous locations, the instrument case should be prevented from being impacted or falling.
- ✦ Do not position the equipment so that it is difficult to operate the disconnecting device.
- ✦ It is strictly prohibited to paste any non-metal labels larger than 400mm<sup>2</sup> on the instrument's casing.

Plug of the external power adaptor is used as disconnect device.

Please use wet cloth (with water) periodic cleaning and maintenance on the instrument.

If the instrument is not used for a long time, please remove the battery to save the battery life.

The equipment may not be covered under warranty if used in manner not specified by the manufacturer.

Prohibited for a long time outdoor use to avoid water or rain.

Avoid using the instrument over-pressure on a long-term basis to avoid damaging the pressure sensor.

Protective boot is not ATEX certified and should not be used in hazardous areas.

#### **CSA MARKINGS :**

- ✦ Reference to a specific installation document to indicate special conditions for safe use preventing installation in an area subject to mechanical impact.
- ✦ “WARNING: SUBSTITUTION OF COMPONENTS MY IMPAIR INTRINSIC SAFETY” and “AVERTISSEMENT: LA SUBSTITUTION DE COMPOSANTS PEUT COMPROMETTRE LA SÉCURITÉ INTRINSÈQUE”
- ✦ “WARNING: DO NOT CONNECT OR DISCONNECT THE RS232 COMMUNICATION CABLE IN A HAZARDOUS ATMOSPHERE” and “AVERTISSEMENT: NE PAS BRANCHER OU DÉBRANCHER LE CÂBLE DE COMMUNICATION RS232 DANS UNE ATMOSPHÈRE DANGEREUSE”
- ✦ “WARNING: TO PREVENT IGNITION OF A HAZARDOUS ATMOSPHERE, BATTERIES MUST ONLY BE CHANGED IN AN AREA KNOWN TO BE NONHAZARDOUS” and “AVERTISSEMENT: AFIN DE PRÉVENIR

- L'INFLAMMATION D'ATMOSPHÈRES DANGEREUSES, NE CHANGER LES BATTERIES QUE DANS DES  
 ✦ EMBLEMES DÉSIGNÉS NON DANGEREUX.”
- “WARNING: USE ONLY TYPE GP 1604A, or PANASONIC 6LR61, 9 V BATTERIES” and  
 ✦ “AVERTISSEMENT - UTILISER UNIQUEMENT DES ACCUMULATEURS GP 1604A, or PANASONIC 6LR61, 9 V”
- N.B: the mark “ ” is only for ADT681 (intrinsically safe version).**

#### 4. Basic structure

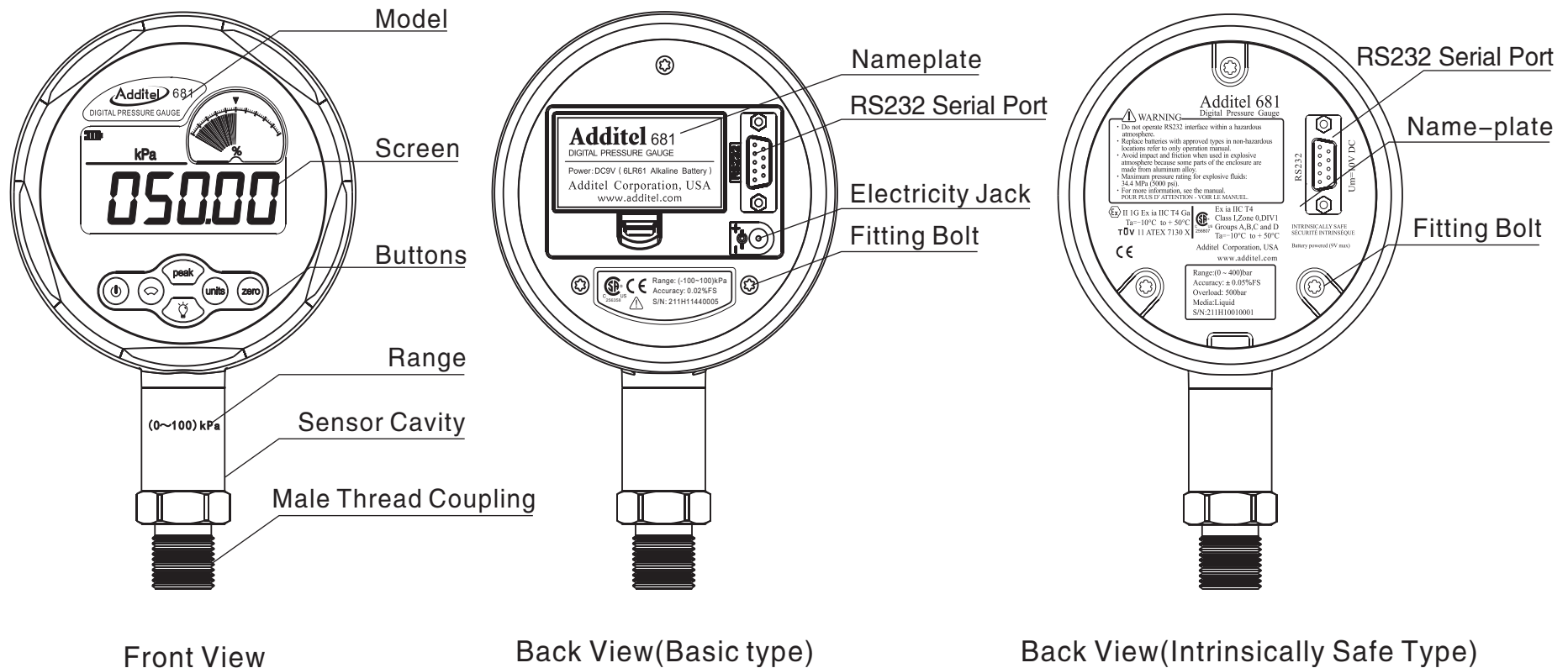

## 5. Keypad function

### (1) Operating instruction



Power ON/OFF



Analogue dial: press quickly to select the % indication, swing (fluctuation) and low/high alarm.

press and hold to enter the set menu for adjusting the low and high alarms.



Peak value: press quickly to switch the indication among max Peak, min Peak and quit Peak.

press and hold to enter the password menu or data logging menu (optional).



Backlight: press quickly to turn on/off the backlight.

press and hold to select the backlight display time (ON, 20s and 30s), and release it after selecting.



Pressure units: press quickly to switch the different pressure units.

press and hold to enter into the temperature display menu.



Zeroing: press for zeroing function, press and hold for zeroing function (the absolute pressure).

### (2) Data inputting introduction

①



units

(←), (→) Move the cursor position.

②



peak



(↑), (↓) Increase/decrease the value nearby cursor with 1 digital.

③



(✓) Confirm the input data.

④



(ESC) Cancel the input data.

### (3) Menu operation introductions

- ① press and hold to enter the set menu or data logging menu(optional).
- ② Use (↑) and (↓) to switch the menu items.
- ③ Press (✓): to select menu function.
- ④ Press (ESC) to exit the menu.
- ⑤ The coefficient input includes integral part and decimal part, for example: input the 4.0146

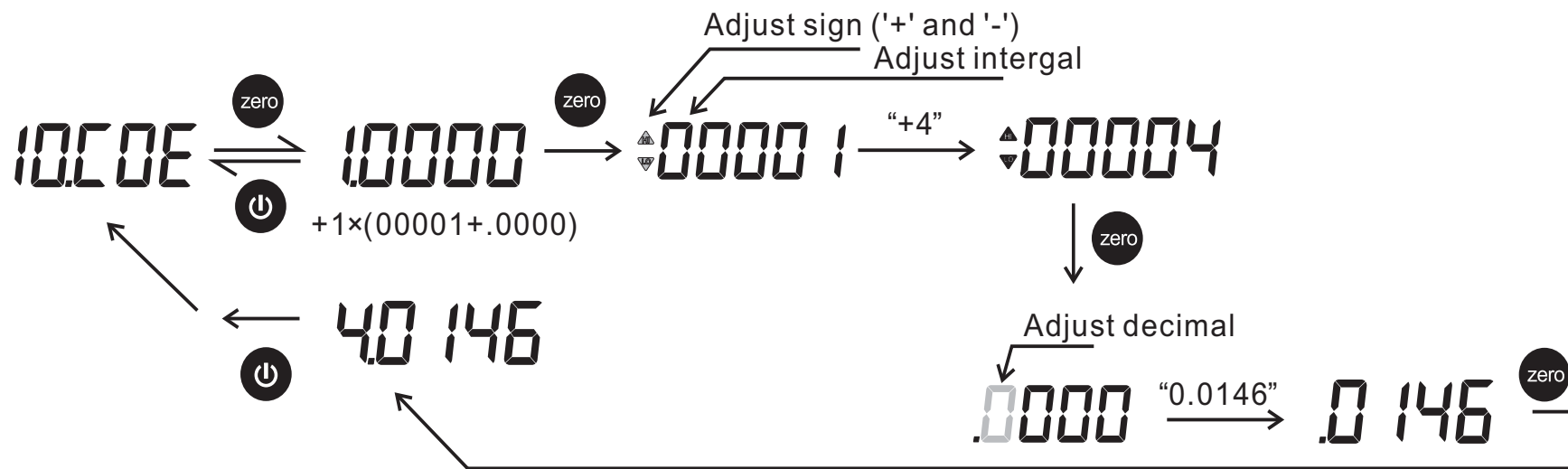

Remark: If the symbol is flashing, please input “+” or “-”

## 6. Display function

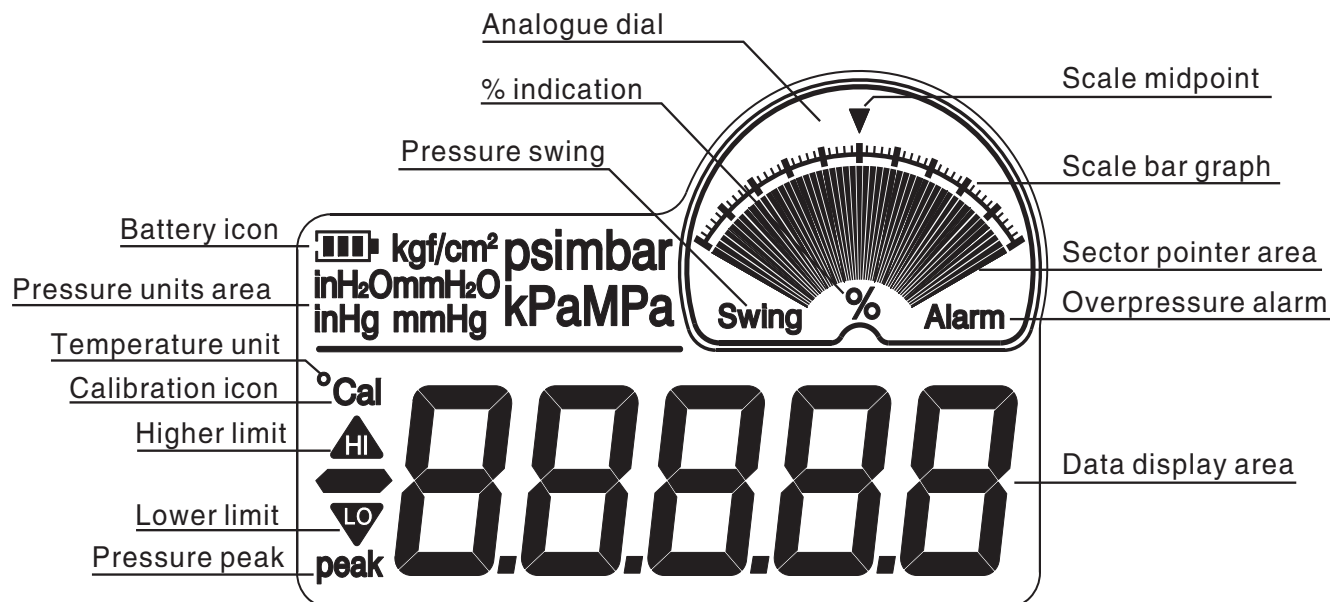

Figure 6–1: Screen area

### The ADT681 screen definitions .

- ◆ **Battery icon:** the battery icon indicates the battery voltage is higher than 7.8V.  
 The battery icon indicates the battery voltage is between 7.8V and 7.3V.  
 The battery icon indicates the battery voltage is between 7.3V and 6.7V.  
 The battery icon indicates the battery voltage is below 6.7V. The battery should be replaced.  
 If the battery voltage is lower than 6.5V, the ADT681 will power off automatically.
- ◆ **Pressure unit area:** Pressure unit area: Eleven common pressure units, and one customized pressure units  
 (The ADT681 has 5 digit resolution based on the unit type selected at time of order) .

- ◆ **Calibration icon:** the mark or symbol of the operating calibration.
- ◆ **Pressure peak:** the mark or symbol of the displaying peak value.
- ◆ **Higher limit:** the mark or symbol of the high limit pressure.
- ◆ **Lower limit:** the mark or symbol of the lower limit pressure.
- ◆ **Temperature unit:** °C.
- ◆ **Data display area:** displays all data or menu.
- ◆ **Analogue dial:** includes 3 types of indications: pressure % indication, pressure swing, overpressure alarm.

The content of the area as follows:

- ① **% indication:** the current pressure percentage.
- ② **Pressure swing:** the indication of pressure fluctuation.
- ③ **Overpressure alarm:** the alarm indication for overpressure (can be set of max/min limits).
- ④ **Sector pointer area:** includes resolution of 51 bars or pointers.
- ⑤ **Scale bar graph:** will vary depending on the analog dial selection.
- ⑥ **Scale midpoint:** the middle position of the scale bar graph.
- ⑦ For optional data logging the flashing icon “%” means the data is logging.

## 7. Basic operation

### 7.1 Power on/off

Press and Hold  about 3s to power on or off the instrument. All the segment of the LCD will display initially illuminate at the power up of the instrument (see Figure 7-1-1). The users can see if there is any damage of the LCD's segment. Then, the LCD will display the software version (Figure 7-1-2) and pressure range (Figure 7-1-4). Lastly, it goes to home screen (Figure 7-1-5). For optional data logging version, there is one more screen between version

screen and pressure range screen (figure 7-1-3).

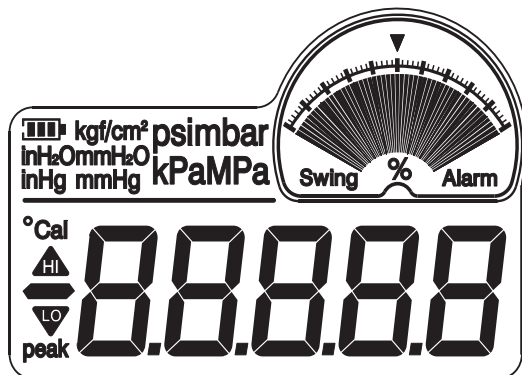

Figure 7-1-1: Power up screen

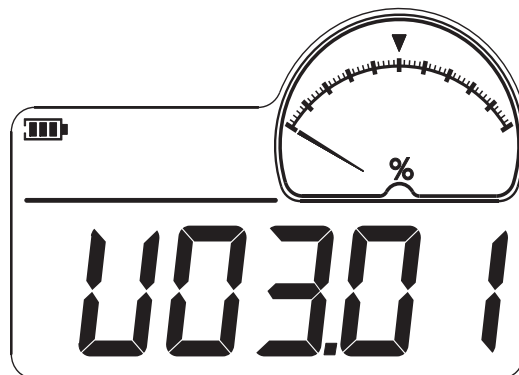

Figure 7-1-2: Version screen

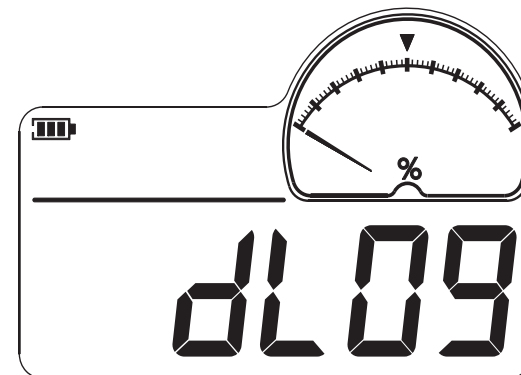

Figure 7-1-3: data logging screen(optional)

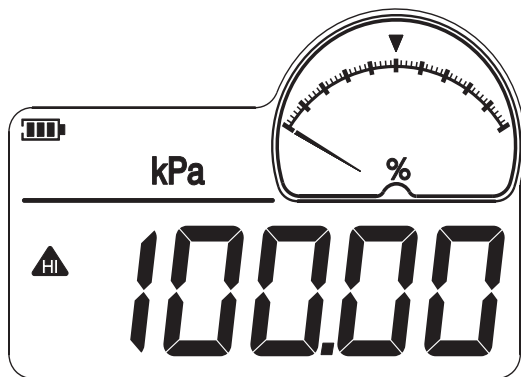

Figure 7-1-4: Upper range screen

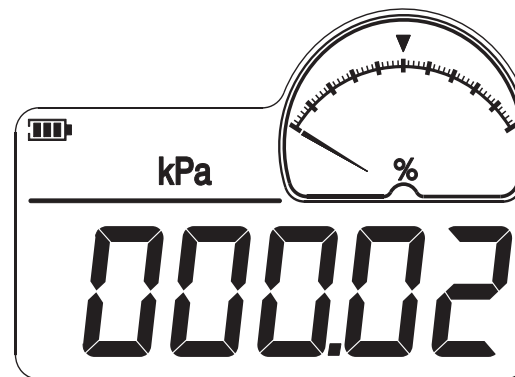

Figure 7-1-5: Home Screen

## 7.2 Pressure measure

When in any menu, pressing returns to the home screen (Figure 7-3). The home screen content includes:

- Battery icon
- Pressure measure value
- Pressure units
- Analogue dial indication

**Note: initially, these register values are set to the factory calibration values. If the pressure exceed 120%FS,**



the whole screen will flash to alert the user. To prevent damage to the sensor, release the pressured immediately. When the alarm goes off, the measure speed of the ADT681 automatically changes to 10 times per sec in order to catch up the pressure change. When the alarm stops, the speed will go back to normal.

### 7.3 Zeroing

(1) Gauge sensor types:

To zero the ADT681 press the  key. Before zeroing the ADT681, the current pressure should be in the range of  $-2\% \sim 2\%$  FS. Figure 7-3-1 shows the zeroing sequence of gauge pressure.

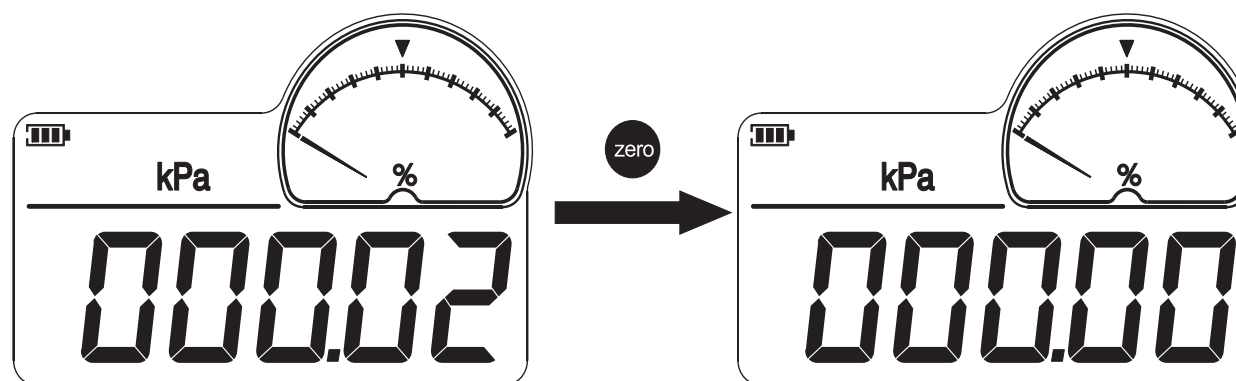



Figure 7-3-1: The zeroing process of the ADT681

(2) Absolute sensor types:

- ① When the ADT681 is connected to atmosphere, the user should know the current atmosphere pressure value ( $P_{\text{standard}}$ ).
- ② The actual pressure of ADT681 is ( $P_{\text{measure}}$ ).
- ③ Press and hold  to enter the data input state, then input the actual pressure ( $P_{\text{standard}}$ ).

- ④ In the pressure measure menu, the measured pressure will change to (Pstandard) which is the same as the atmosphere pressure value. Now the zeroing process is finished.

Figure 7-3-2 shows the zeroing sequence for absolute pressure of the ADT681.

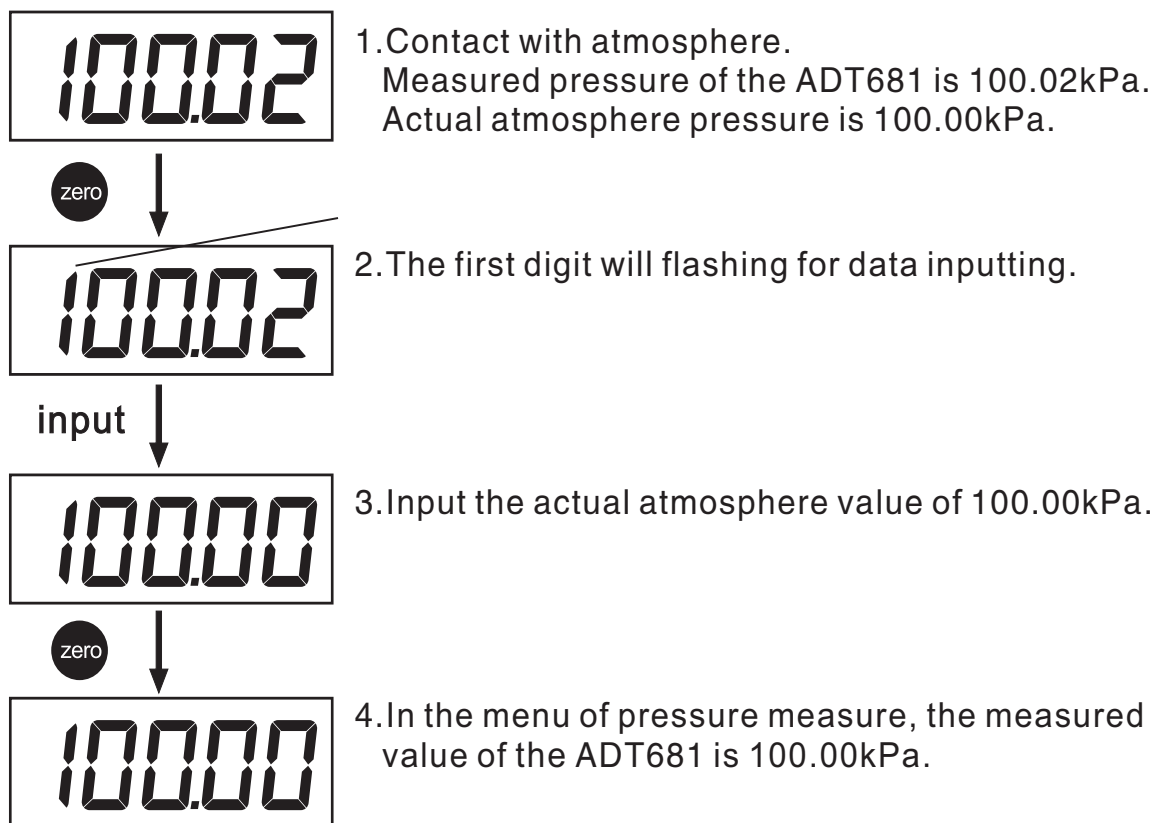

Figure 7-3-2: Zeroing process of absolute pressure

- Note:** A. When selecting the third item **30LT** in the MENU OPTION you can cancel the zeroing operation.  
B. Make sure the gauge is upright while zeroing.

## 7.4 Pressure units

Press **units** to view and select among the pressure units. The order is Pa, kPa, Mpa, customized unit, kgf/cm<sup>2</sup>, inH<sub>2</sub>O, mmH<sub>2</sub>O, inHg, mmHg, psi, mbar, bar. The conversion relation of all pressure units is as following table 7-4-1.

Pa	kPa	kgf/cm <sup>2</sup>	inH <sub>2</sub> O	mmH <sub>2</sub> O	inHg	mmHg	psi	mbar	bar	MPa	C
1000	1	0.010197	4.01463	101.97162	0.2953	7.50062	0.1450377	10	0.01	0.001	customized unit

Table 7-4-1: Pressure units' conversion relation

**Note:** in order to avoid readings that are too long or too short for the units parameters, be sure to select pressure units that are compatible with the ADT681.

Figure 7-4 shows the methods to switch the different pressure units.

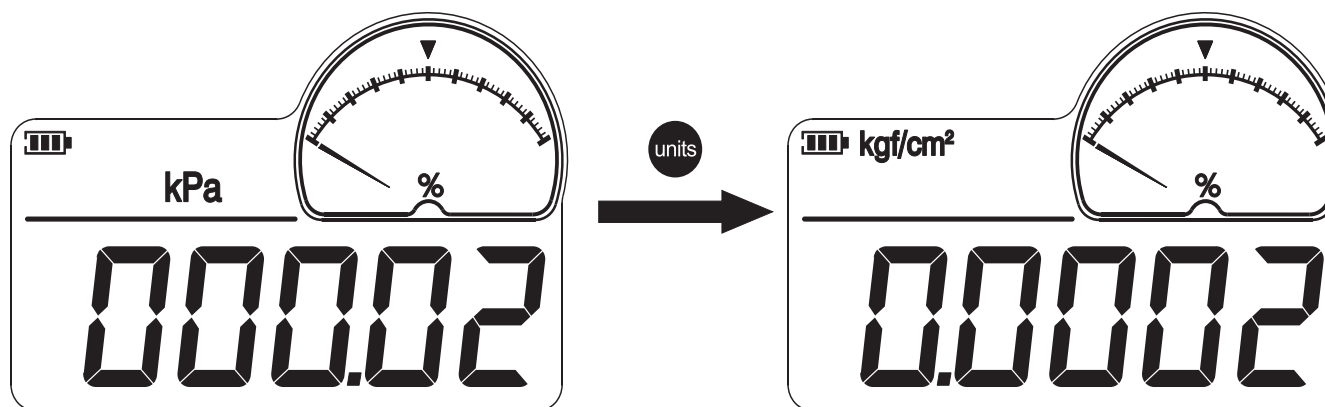



Figure 7-4: Switching method

## 7.5 Peak detection

(1) The ADT681 will automatically record the max/min pressure values.

Press  to view them.

 -----Shows max pressure.

 -----Shows min pressure.

Press  and the gauge will return to the measure menu. The max/min pressure values will be automatically recorded.

(2) To reset the peak values.



Press  to enter the peak value menu, press  to clear peak value.

Figure 7–5 shows the display of the peak values.

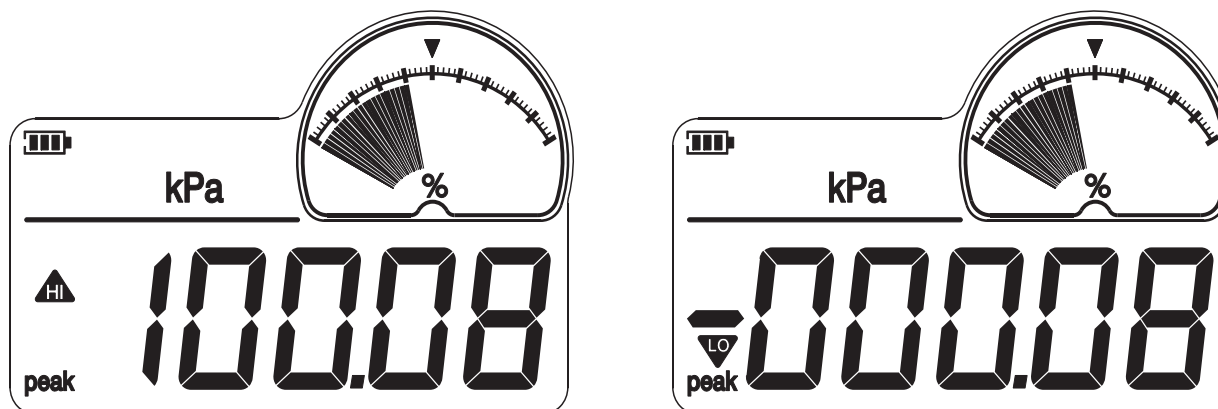

Figure 7–5: Display peak value

## 7.6 Backlight

Press  to power on/off the backlight. The selectable times are ON, 20 seconds and 30 seconds.

The selection method is as follows:

(1) Press  and hold to display and select among the following options.

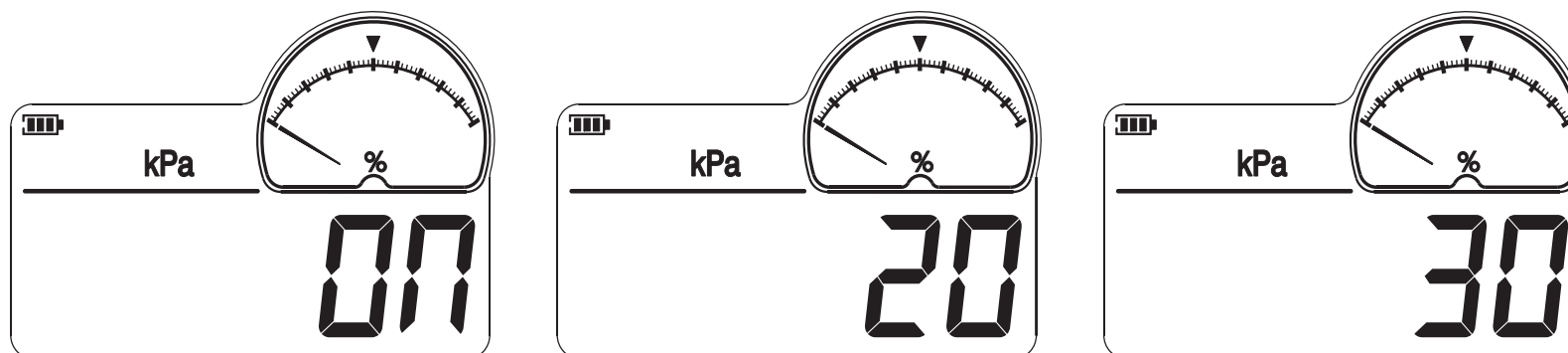



Figure 7-6: Backlight auto power off options

(2) Press  and hold to select auto power off time setting (ON, 20, 30), then release when the desired option appears.

## 7.7 Analog dial

Includes three indications: % of pressure indication, pressure swing and overpressure alarm.

Press  to switch from one to the other.

The analogue dial includes:

- ① Percentage of pressure (%)      ② Pressure swing      ③ Overpressure alarm
- ④ Sector pointer area              ⑤ Scale bar graph      ⑥ Scale midpoint
- ⑦ For optional data logging the flashing icon “%” means the data is logging.

### 7.7.1 Percent pressure

- ◆ % indicator: shows the current pressure percentage.
- ◆ Sector pointer area: shows the pressure ranges and the trend of pressure changes in a fan-shaped pattern.

**Note: the differential pressure, gauge pressure, absolute pressure, Compound pressure types have different displays.**

- ◆ Scale bar graph: 0%~100%, the minimum scale is 2%.
- ◆ Scale midpoint: point to 50%.

**Example: for the ADT681 with (0~100) kPa, if the current pressure value is 50kPa, the % indicator is 50%, as figure 7-7-1.**

### 7.7.2 Pressure swing

- ◆ Pressure swing icon: indicates the pressure fluctuation.
- ◆ Sector pointer area: uses one pointer to show the fluctuation degree of two adjacent separate pressure values.
- ◆ Scale bar graph: range is (-0.25%~0.25%) FS, the min scale is 0.01%FS.
- ◆ Scale midpoint: point to 0.00%FS position

**Example: for the ADT681 with (0~100) kPa, if the current pressure reading is 50.01kPa and the previous pressure was 50.11kPa, the fluctuation degree for 2 separate pressures is - 0.1%FS, as figure 7-7-2 shows.**

### 7.7.3 Overpressure alarm

- ◆ Overpressure alarm icon: indicates an overpressure condition.

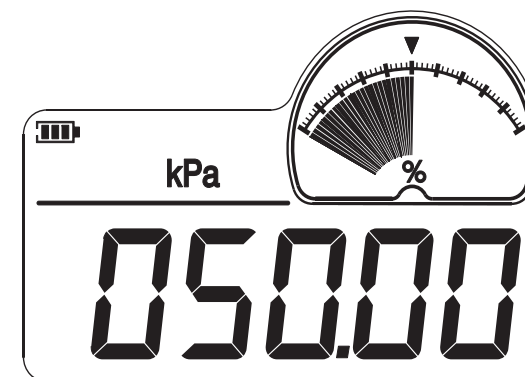

Figure 7-7-1: Pressure % indication

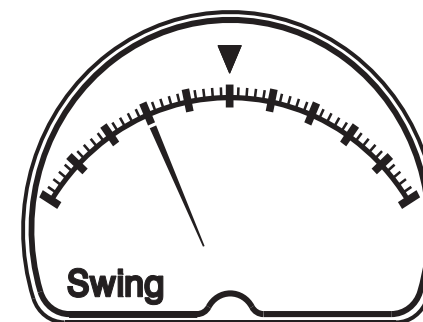

Figure 7-7-2: Pressure swing indication

- ◆ Sector pointer area: two pointers to show the high/low alarm limit pressure percentage, the 3<sup>rd</sup> pointer shows the current pressure percentage.
- ◆ Scale bar graph: (0%~100%) FS, minimum scale is 2%FS.
- ◆ Scale midpoint: point to 50%.

**Example: for the ADT681 (pressure range 0–100kPa),if the current pressure reading is 50.00kPa (50%FS) and the higher limit is 80kPa (80%FS)and the lower limit is 40kPa (40%FS), the analogue dial will show as figure 7–7–3.**

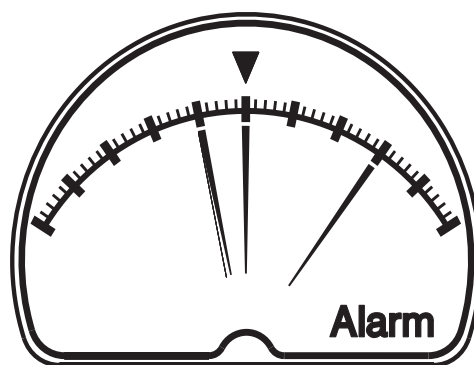







Figure 7–7–3: Overpressure Alarm

When the current pressure is beyond the range of the high/low limit, the whole screen will flash to warn the user to adjust the pressure. Meanwhile, In order to catch up to the pressure change, the measure speed will automatically adjust to ten times per second. Once the alarm is over, the display will go back to normal speed.

#### 7.7.4 Setting alarm limit

To set the alarm limit:

- (1) Press and hold  display the higher limit  and the lower limit  then move the cursor up or down by pressing  or  .

- (2) Press **units** or **zero** to access the alarm adjust status, then when **HI** is displayed, the higher pressure limit can be set, when **LO** is displayed, the lower pressure limit can be set. After these steps are completed, press **↩** to select negative (-) or positive (+) values.
- (3) After the high limit is adjusted, the menu will automatically enter the lower limit and then return to the normal screen. The sequence is: High limit, Low limit, Quit.
- (4) The ADT681 automatically checks the validity of the input data. If there is a problem or if the data input is not valid, the ADT681 will not accept the change. Figure 7-7-4 shows the setting menu.

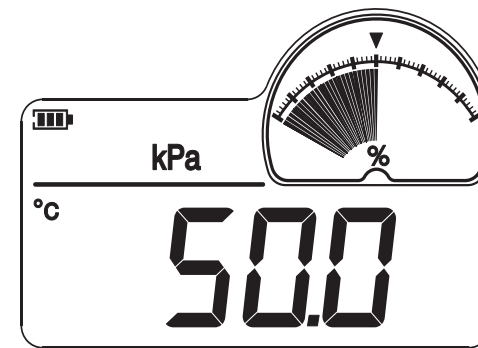
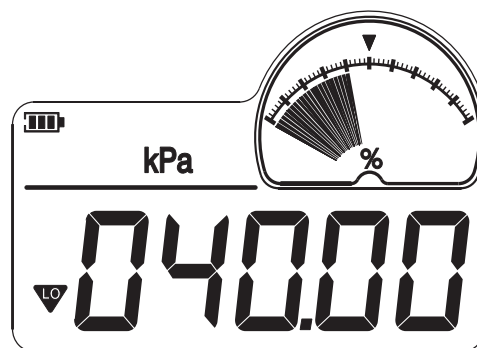
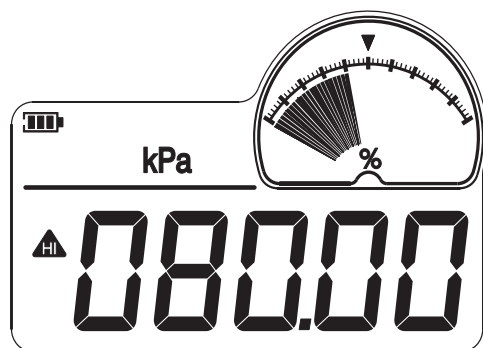

Figure 7-7-4: The setting menu of the high or limit and the lower limit

Figure 7-8: Temperature measure menu

## 7.8 Temperature measure

Press **units** and hold to enter the temperature measure menu, press **units** again to go back to the pressure measure menu. The temperature measure range is  $-30^{\circ}\text{C} \sim 90^{\circ}\text{C}$ , the minimum resolution is  $\pm 0.1^{\circ}\text{C}$ .

Figure 7-8 shows the temperature measure menu.



## 7.9 Data logging (optional)

### 7.9.1 Save menu

Press and hold the  button to enter into the data logging menu. The screen shows

**1dL09** (data logging) and **25Et** (set menu), please select the **1dL09**.

- (1) **1tEt** : 1. Display the date and time. 2. Set up the date and time.
- (2) **2CAP** : Memory capacity status.
- (3) **35ENd** : Upload data.
- (4) **4dEL** : Delete all data, the password is "211".
- (5) **59AP** : Logging interval (00001s–99999s).
- (6) **6OFF** : "on" means to start data logging, and "off" means to stop the data logging.

Remark: when capacity is full, please delete all data for logging new data.

### 7.9.2 To log data

- (1) Set up the date and time                      (2) Set up the logging interval                      (3) Start to log

**Examples: Automatic storage, the interval is 1 second:**

- ① Set up the actual date and time (No. **1tEt** )
- ② Select the gap menu option (No. **59AP** ) and set up the logging interval as 00001S.
- ③ Change the logging status to "on" (No. **6OFF** )
- ④ Return to main menu. The % icon should be flashing to indicated data logging is active.
- ⑤ Except for the  button, all other buttons are locked.

- ⑥ The data can be sent by Additel/Land software.

Remark: While the Additel 681 is sending data, it will stop logging.

- ⑦ Press “del” in the data logging menu to delete all data, the password is 211.

### 7.9.3 Export data via Additel/Land software.

(available for free download at <http://www.additel.com/products/Software/>)

- (1) Connect the Additel 681 with computer, run Additel/ Land software.

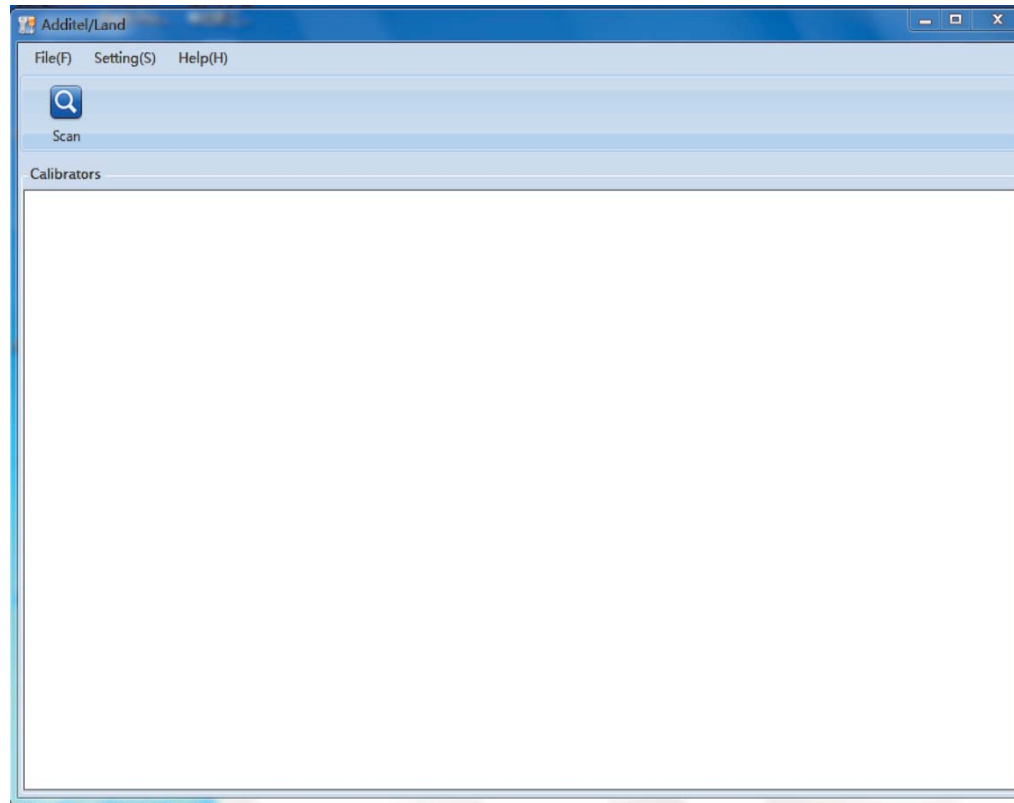

7-9-3-1

(2) Click the button “Scan” , you will see the picture below.

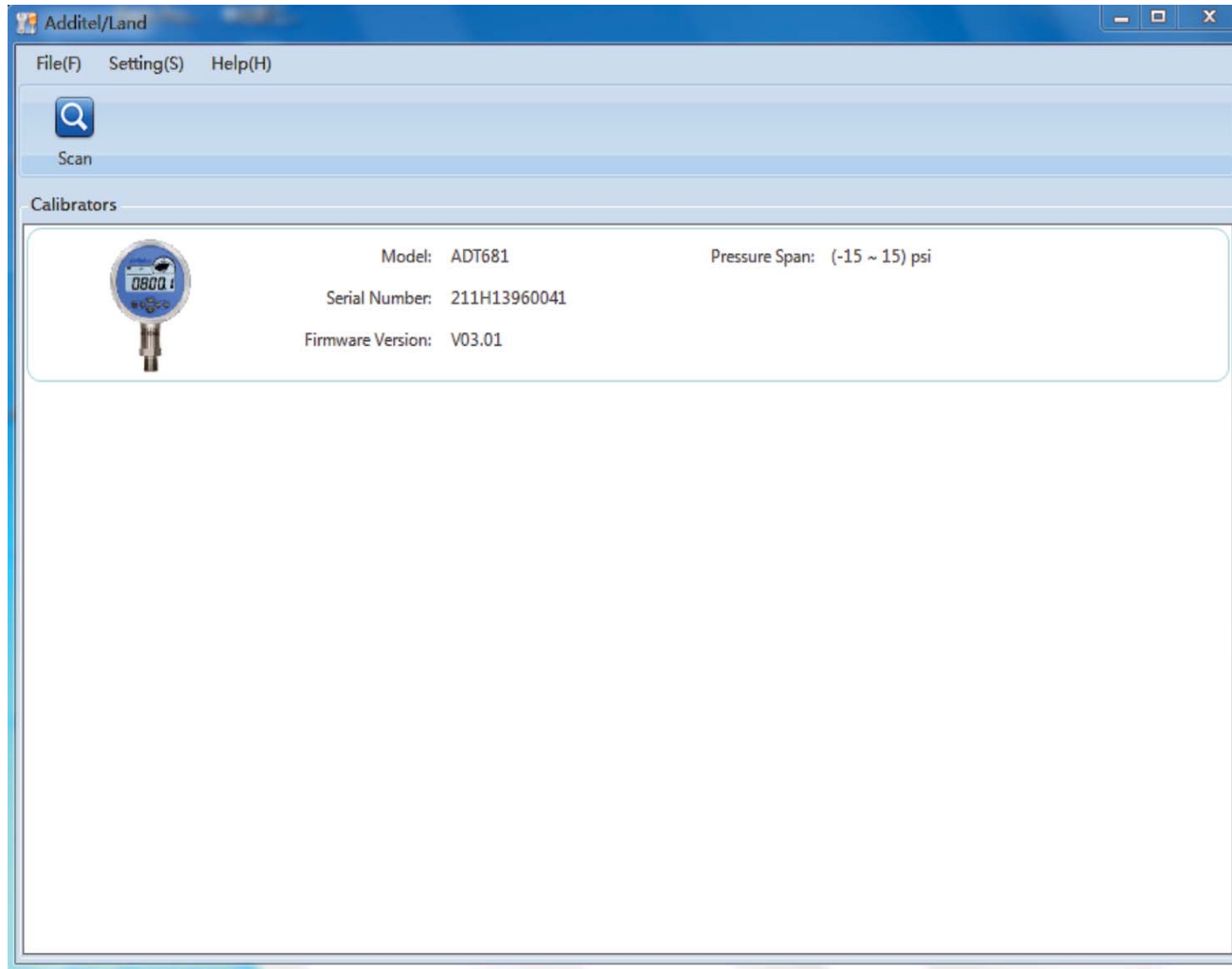

7-9-3-2

(3) After clicking the Additel 681, the next window will appear as below.

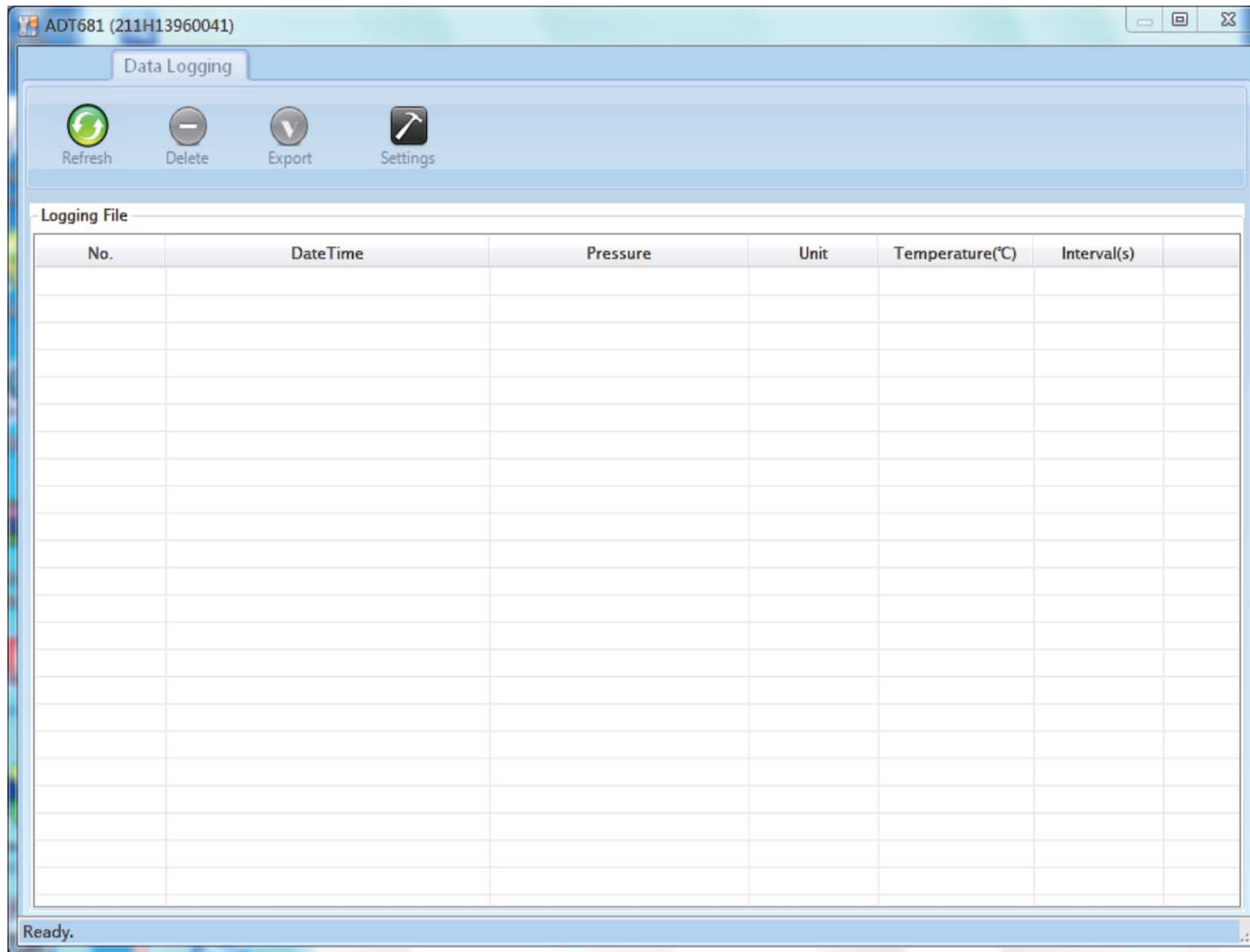

7-9-3-3

(4) Click the “Refresh” button to send data from Additel 681 to software.

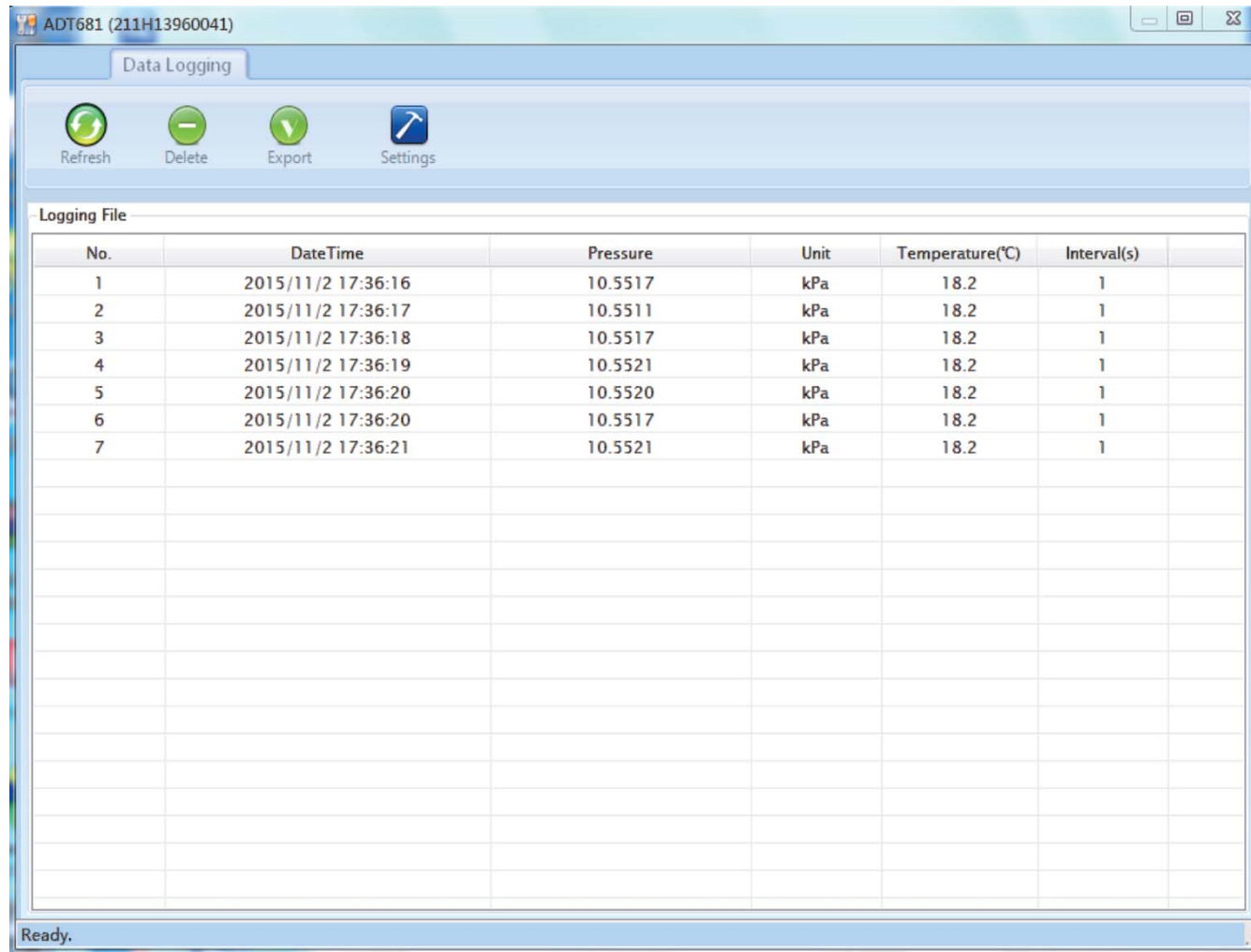

7-9-3-4

(5) Click the “Export” button to send the data with EXCEL format.

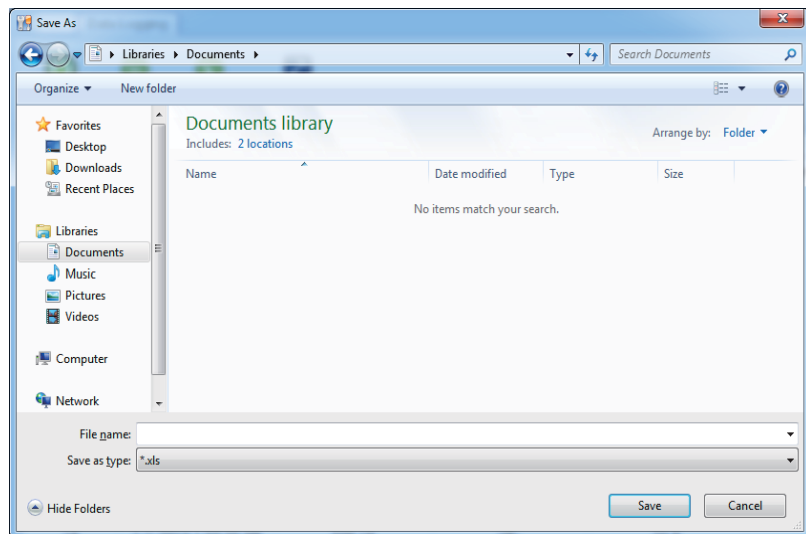

7-9-3-5

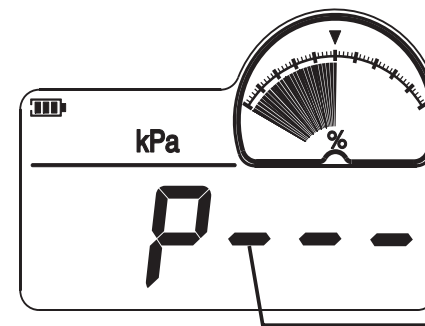

Flashing, input password

Figure 8-1-1: Enter the password menu

(6) Press the “delete” button to delete all data

## 7.10 Factory Menu

### 681 without data logging:

Note: Please consult Additel Corporation before making any adjustments to the factory menu.

(1) Press and hold the **peak** button to enter into the set menu (password).

(2) Input password “724” .

Shown in Figure 7-10-1

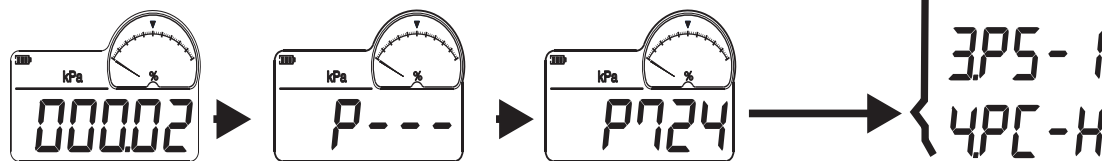

Figure 7-10-1: Factory Menu in 681 without data logging

### 681 with data logging:

Press and hold the  button to enter into the data logging menu. The screen shows

**1dL09** (data logging) and **2.5Et** (set menu), please select the **2.5Et**, with password “724” .

Shown in Figure 7-10-2

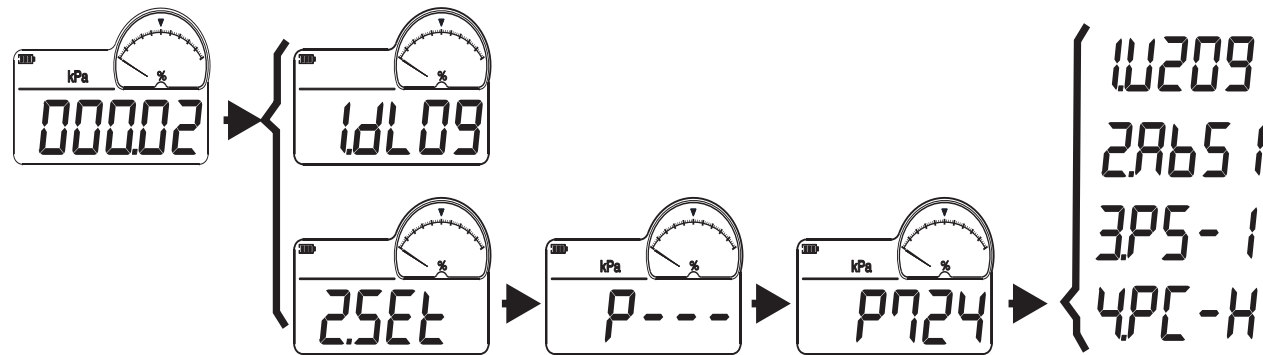
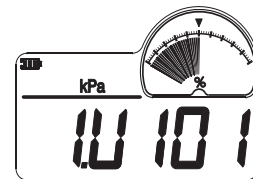
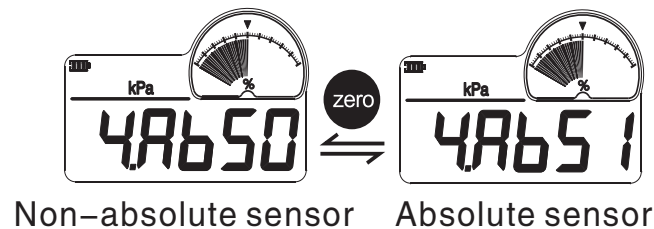

Figure 7-10-2: Factory Menu in 681 with data logging

(1) Firmware version number, can not be changed



(2) Zero function, settable as non-absolute/absolute sensor



(3) Select pressure sensor power supply type

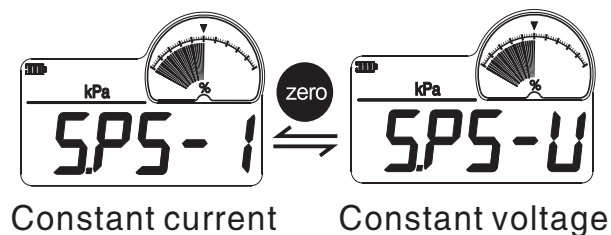

(4) Select pressure sensor power mode: High / Low

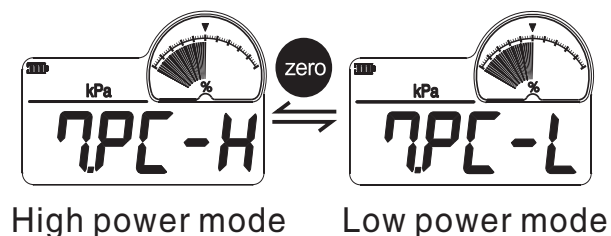



## 8. Menu operation

### 8.1 Enter the Menu

(1) Press and hold the  button enter into the set menu (password), as shown in Figure 8-1-1.

(2) Input password “211” .

Remark: For Additel 681 with data logging, Press and hold the  button to enter into the data logging menu.

The screen shows  (data logging, see more details in 7.9) and  (set menu)

**Note: if the password is wrong, the menu will return to the previous menu.**



## 8.2 Menu option

There are 12 options, as shown in Figure 8-2-1.

1.CAL	4.FLE	7.BAUD	10.COE
2.C-0	5.FLT 1	8.OFF	11.LAT
3.CLT	6.ADDT	9. 1t5	12.SP

Figure 8-2-1: 12 menu options

Details as below:

- (1) 1.CAL To enter into the calibration menu.
- (2) 2.C-1 The ADT681 has been calibrated already.
- 2.C-0 The ADT681 hasn't been calibrated yet.

If this step is used, all pressure calibration will be cancelled. Be careful when using this operation.

- (3) 3.CLT cancels the previous zeroing operation.
- (4) 4.FLE sets measure speed.
- (5) 5.FLT 1 sets filtering effectively.
- (6) 6.ADDT sets the address of RS232.
- (7) 7.BAUD sets the baud rate of Rs232.
- (8) 8.OFF set automatic shutdown timer time.
- (9) 9. 1t5 sets 4 or 5 digit display.
- (10) 10.COE set custom unit factor.

(11) **11TAR** set tare function.

(12) **12SPC** set single-point calibration.

### 8.3 Enter/cancel the calibration

**1CAL** enters the calibration.

**2C-1** cancels the calibration.

### 8.4 To cancel the previous zeroing

**3CLT** cancels the previous zeroing operation.

### 8.5 To set measure speed

Select **4-ALC** to enter the selection menu of the measure speed as follows:

CON(10 times/1 sec)    1—3 (3 times/1 sec)    1—2 (2 times/1 sec)    1—1 (1 times/1 sec)    2—1 (1 times/2 sec)

3—1 (1 times/3 sec)    4—1 (1 times/4 sec)    5—1 (1 times/5 sec)    6—1 (1 times/6 sec)    7—1 (1 times/7 sec)

8—1 (1 times/8 sec)    9—1 (1 times/9 sec)    10—1 (1 times/10 sec)

The factory default is 1—3 (3 times/1 sec).

### 8.6 To set filtering effectively

Select **5FLT 1** for "filtering is valid", **5FLT 0** for "filtering is invalid".

### 8.7 Set RS232 address

Select **6ADDR** to set the RS232 address from the range 1 to 112. The factory default is 1.

### 8.8 To set the RS232 baud rate

Select **7BAUD** to set the RS232 baud rate from the options of 2400 and 4800 and 9600. The factory default is 9600.

---

### 8.9 To set the automatic shutdown

Select **88OFF** , sets the automatic shutdown function. (1/5/10/15/30/45/60/90/120 minutes and off function can be set)

### 8.10 To set the 4 or 5 digit display

Select **96 125** to change the 4 or 5 digit display.

### 8.11 Set custom unit factor

Select **10COE** , sets the coefficient of customized pressure units. In the other words, user can customize a pressure unit by setting a conversion ratio based on pressure unit “kPa” . This ratio's range is from 0.0001 to 99999, but only shows 5 digits.

For example: The coefficient is 1000 as coefficient, the display pressure value is equal with the pressure with unit “Pa” . The symbol of customized pressure unit is “C” . The conversion format: 1kPa = coefficient x C.

### 8.12 Set tare function

Select **11TAR** , sets a pressure as new reference zero (the pressure unit should be kept the same as main menu).

### 8.13 Set single-point calibration

Select **12SPC** , sets single point calibration.

- (1) Pressure zeroing
- (2) Set one non-zero pressure point, records the display pressure readings.
- (3) Calculate the adjustment ratio accordingly and set it in the Additel 681.

Example: Set 1.65kPa standard pressure, but the display pressure reading is 1.5kPa. In order to correct the display

pressure readings, you should make an adjustment ratio  $q=1.65/1.5=1.1$ . After input the ratio 1.1, all readings will be multiplied 1.1. Therefore, if you set 1.65KPa again, the display reading is 1.650 ( $1.500 \times 1.1 = 1.650$ )

Remark: the adjustment ratio range is 0.0001 ~ 9.9999

## **9. Calibration function**

It is recommended that the ADT681 be calibrated once per year by a trained professional. For best results before calibration, the ADT681 should be exercised to full scale three times. If there is an error during the process then use the cancellation function.

**Note: all calibration must take place in stable ambient laboratory conditions.**

### **9.1 Calibration conditions**

- (1) Environment: temperature:  $20^{\circ}\text{C} \pm 2^{\circ}\text{C}$ , relative humidity: (45–75) %, atmosphere pressure: (86~106) kPa.
- (2) Standard pressure source. Example: Dead weight tester or Additel 9XX series pressure pumps.
- (3) High precision reference standard.

### **9.2 Calibration process**

Select Menu to enter the calibration menu. There are two different pressure gauges:

- (1) Single scale gauge: to calibrate, first set the "low", then pressurize to set the "high".
- (2) Dual scale gauge: first set the lower limit, then zero, then set the higher limit.

The calibration point can be modified if it meets the following conditions:

- (1) The pressure value of the 1<sup>st</sup> point is lower than the 2<sup>nd</sup> point.
- (2) The pressure value of the 2<sup>nd</sup> point value is lower than the 3<sup>rd</sup> point.

Example: the ADT681 with (0~100) kPa.

- (1) Select **ICAL** and press **zero** to display the calibration value of lower limit, as the figure 9-2-1. If the user needs to modify the pressure value of the low limit point then input the desired value. Otherwise, press **zero** to confirm.
- (2) To calibrate the lower limit point: press **zero** to confirm till the actual pressure value is stable. As in Figure 9-2-2.
- (3) Display higher limit point: as in Figure 9-2-3, input the desired data if the user needs to modify the calibration value. Otherwise, press **zero** to confirm.
- (4) To calibrate the higher limit point: press **zero** until the actual pressure value is stable. As in Figure 9-2-4.

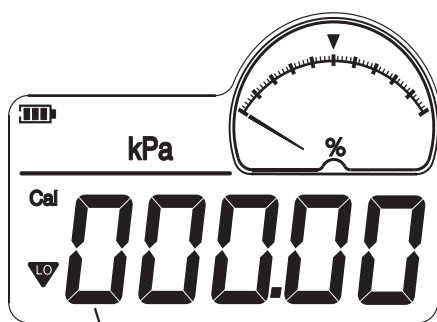

Flashing,input new calibration point

lower limit point display menu

Figure 9-2-1

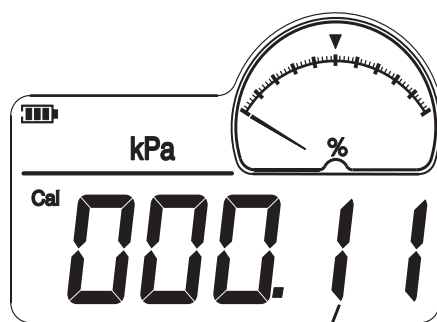

The actual pressure measurement value

lower limit calibration menu

Figure 9-2-2

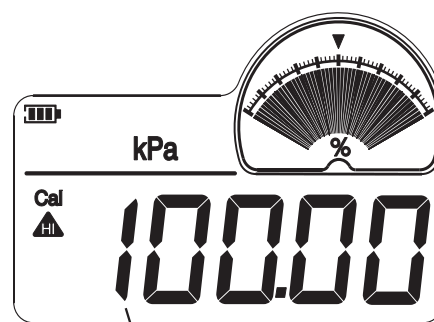

Flashing,input new calibration point

higher limit point display menu

Figure 9-2-3

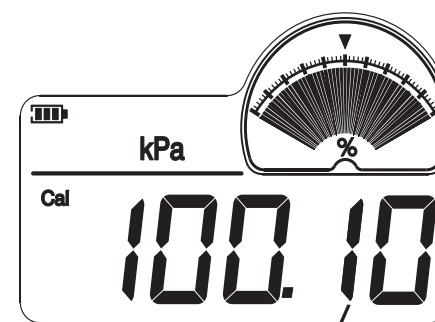



The actual pressure measurement value

higher limit calibration menu

Figure 9-2-4

(5) When the screen returns to the calibration menu, the 2<sup>nd</sup> option will change to **20-1**. This shows the calibration is complete.

**Note:** three-point pressure calibration is **similar to** the two-point. The only difference is **that the icons will display   while the zero is calibrated.**

### 9.3 Cancel calibration

Select **20-1** and push  to cancel the calibration, then the screen will display **20-0**.

## 10. Power supply description

The ADT681 has two power sources: a 9V alkaline battery(ANSI/NEDA 1604A or IEC 6LR61) or special DC9V adapter.

(1) Standard type:

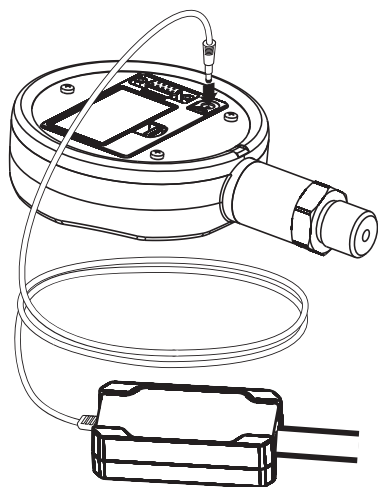

Figure 10-1-1: Connect the adapter diagram

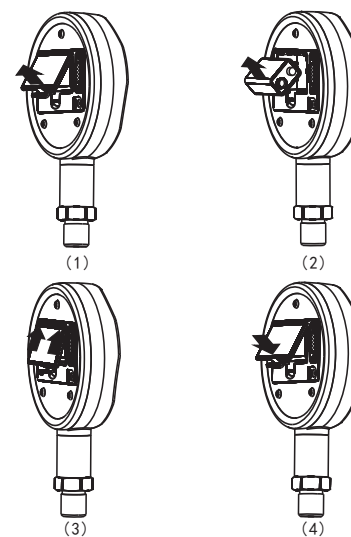

Figure 10-1-2: Battery installation diagram

(2) Intrinsically safe type:

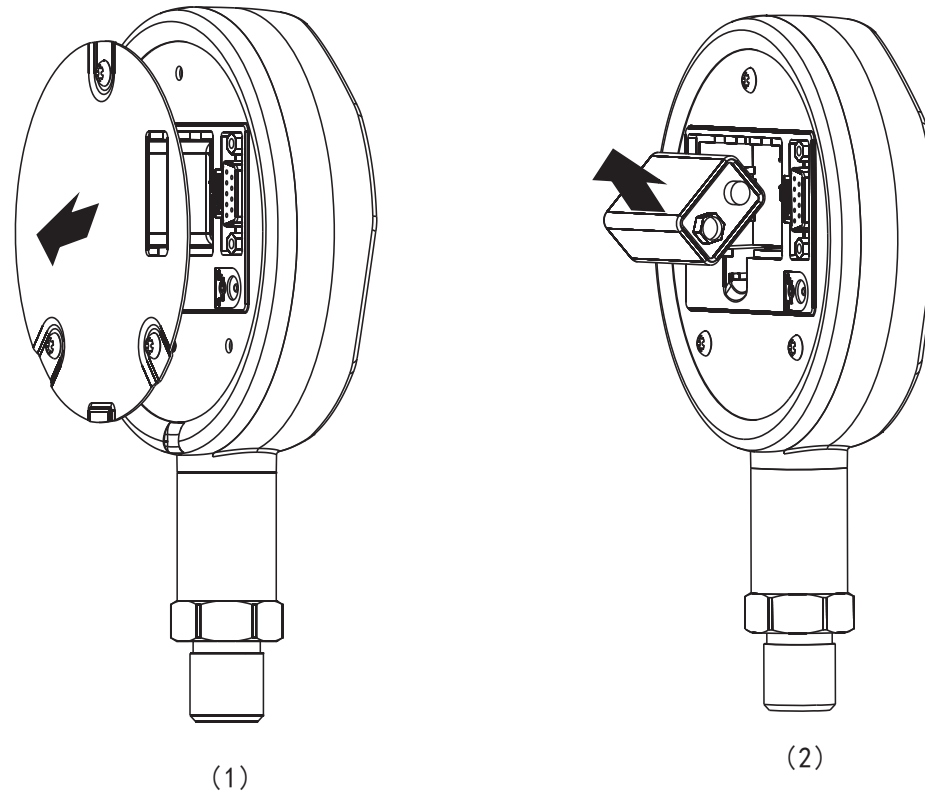

Figure 10-2-1: Battery installation diagram

**Warning:**

- ◆ Replace the battery if the ADT681 powers off automatically.
- ⚡ Remove the ADT681 from the Ex-hazardous area before opening the battery door.
- ⚡ Use only the battery types listed in the Approved Battery Table.
- ◆ When replacing the battery, make sure positive and negative are in the right direction.

**Approved Batteries:**

Battery	Manufacturer	Type
Alkaline, 9 volt	Panasonic®	6LR61 9V
Alkaline, 9 volt	<b>GP</b>	1604A 9V
Alkaline, 9 volt	Nanfu	6LR61 9V
Alkaline, 9 volt	Energizer	6LR61 9V
Alkaline, 9 volt	DURACELL	6LR61 9V

**11.Measure speed and Working time**

1. In high power mode, working time is 320 hours, not related to measure speed.
2. In low power mode, working time is:

Measure speed	10times/1sec	3times/1sec	2times/1sec	1time/1sec	1time/2sec	1time/3sec	1time/4sec	1time/5sec~1time/7sec	1time/8sec~1time/10sec
Battery life	300hours	600hours	800hours	1250hours	1750hours	2500hours	3000hours	3600hours	4000hours

Table11-1



## 12. Accessories

(1) Warranty	1pc
(2) User's Manual	1pc
(3) Adapter 9812-X	1pc (optional)
(4) Pressure test report	1pc
(5) Traceable certificate of calibration	1pc (optional)

## 13. Contact us

The product specifications and other information contained this manual are subject to change without notice. Additel Corporation has made a concerted effort to provide complete and current information for the proper use of the equipment.

If there are questions, contact Additel Corporation:

Additel Corporation

2900 Saturn Street #B

Brea, CA 92821, USA

Phone: 714-998-6899

Email: [service@additel.com](mailto:service@additel.com)

website: [www.additel.com](http://www.additel.com)

## **Appendix I: Communication protocols**

### **1. Instructions format**

#### **1.1 PC machine's send format**

A: X: Knnnn: C0: C1: C2: C3: C4+ Eos (End of symbol)

A: 1 byte, the communication address of ADT681

X: 1 byte, only for W (write) or R (read)

K: 1 byte, M (for measure operation), F (for file operation), O (other operation)

nnnn: 2–5 bytes, the item operated by K instruction

C0:C1:C2:C3:C4: Parameter, refer the specified instruction introduction

Eos: 0x0(Hex)

#### **1.2 Return format of the ADT681**

A: X: Knnnn: C0: C1: C2: C3: C4+Eos, hereinto:

A: Communication address of the ADT681

X: E or F, E: error information of this frame data. F: feedback information.

Knnnn: It is same as the instructions from upper machine

C0, C1, C2, C3, C4: Feedback data or error information or ok

Eos: 0x0(Hex)

#### **1.3 Error information code instruction**

1000: Receive the overflow from buffer zone.

1001: The user cannot perform this task

1004: Irregular code has been entered

1005: The pressure unit is unavailable

- 1007: The parameter settings are irregular
- 1016: The current data is not the range of zeroing
- 1017: The number of parameters entered does not meet the parameter settings
- 1018: This instruction is non-existent
- 1019: The length of the operation code is too long
- 1020: The r/w of instruction is wrong
- 1024: The setting of pressure unit is irregular
- 1025: The serial port's address code is too long
- 1026: The baud rate is wrong
- 1029: Some parameter codes are too long

#### 1.4 The series port's communication collocation

Communication Address	Baud rate	Data length	Stop bit	Parity bit	Flow control
1 ~ 112	2400 4800 9600	8	2	N/A	N/A

The protocol supports two types of address format as following:

1. 1-byte address, the address is a hexadecimal. Example:  
[0x01]: R: MRMD: [terminator], the terminator is 0x0x0, 0x0a or 0x0d;
2. 3-byte address, the address is a string. Example:  
[001]: R: MRMD: [terminator], the terminator is 0x00, 0x0a or 0x0d;  
[255]: R: MRMD: [terminator], '255' is a universal address. It will be work whatever the calibrator's address is.

## 2. Instructions details

Instructions									Function Introduction	Right return value
A	X	Knnnn	C0	C1	C2	C3	C4	Eos		
	R	OVER	-	-	-	-	-	0x0	Read the software version number	A: F: OVER: version No.+Eos
	R	OTYPE	-	-	-	-	-	0x0	Read the instrument model number	A: F: OTYPE: instrument model No.+Eos
	R	OCODE	-	-	-	-	-	0x0	Read the serial number of the instrument	A: F: OCODE: serial number+Eos
	R	OPRDA	-	-	-	-	-	0x0	Read the manufacture date of the instrument	A: F: OPRDA: manufacture date+Eos
	W	OBLAC	0 (close) 1 (open)	-	-	-	-	0x0	On/off backlight	A: F: OBLAC: OK+Eos
	W	OBLAT	0/20/30	-	-	-	-	0x0	Set the time of backlight turn off Option:ON、20s、30s	A: F: OBLAT: OK+Eos
	W	OKEY	0 (close) 1 (open)	-	-	-	-	0x0	On/off keypad	A: F: OKEY: OK+Eos
	R	OBATV	-	-	-	-	-	0x0	Read the voltage of battery	A: F: OBATV: battery voltage+Eos
	R	ORAN	-	-	-	-	-	0x0	Read instrument's pressure range Pressure type:0(gauge) 1(absolute)	A: F: ORAN: lower limit: upper limit: pressure unit: pressure type+Eos
	R	MRMD	-	-	-	-	-	0x0	Read the actual pressure value	A: F: MRMD: pressure value: unit+Eos
	R	OTEMP	-	-	-	-	-	0x0	Read the environment temperature	A: F: OTEMP: temperature: °C+Eos
	W	MZERO	-	-	-	-	-	0x0	Cancel the zeroing pressure	A: F: MZERO: OK+Eos
	W	OZERO	-	-	-	-	-	0x0	Zero the pressure value	A: F: OZERO: OK+Eos
	W	OCONT	0 (close) 1 (open)	-	-	-	-	0x0	Set the sending data continuously	A: F: OCONT: OK+Eos
	W	OUNIT	Unit shortening	-	-	-	-	0x0	Switch the pressure units	A: F: OUNIT: OK+Eos
	R	OUIINF	-	-	-	-	-	0x0	Read the code of optional units	A: F: OUIINF: unit info code +Eos
	R	OPEAK	-	-	-	-	-	0x0	Read pressure peak value	A: F: OPEAK: max peak value: min pear value: pressure unit +Eos
	W	OPKZE	-	-	-	-	-	0x0	Zero pressure peak value to actual measured pressure value	A: F: OPKZE: OK+Eos
	R	OADDR	-	-	-	-	-	0x0	Read series port address(1-112)	A: F: OADDR: address +Eos
	W	OADDR	Address	-	-	-	-	0x0	Set up the series port address	A: F: OADDR: OK+Eos
	W	OBAUD	Baud rate	-	-	-	-	0x0	Set the baud rate (2400,4800,9600)	A: F: OBAUD: OK+Eos
	W	OFALT	-	-	-	-	-	0x0	Cancel the pressure parameter to operation, go back to factory default	A: F: OFALT: OK+Eos

Instructions									Function Introduction	Right return value
A	X	Knnnn	C0	C1	C2	C3	C4	Eos		
	W	OFRUN	0(stop) 1(start)	-	-	-	-	0x0	Set data logging start or stop	A:F: OFRUN:OK+Eos
	W	OFTIM	interval	-	-	-	-	0x0	Set recording interval (1s~99999s)	A:F: OFTIM:OK+Eos
	R	OFSTA	-	-	-	-	-	0x0	Read the operating status of data logging	A:F: OFSTA:state:interval:space:total records+Eos
	W	OFDEL	211	-	-	-	-	0x0	Delete all data records	A:F: OFDEL:OK+Eos
	W	OFSAP	0(stop) 1(start)	-	-	-	-	0x0	Send all data records	A:F: OFSAP:OK+Eos Automatically send data packets, detailed packet format, please contact the manufacturer
	R	ORTC	-	-	-	-	-	0x0	Read RTC	A:F:ORTC: yymmddhhmmss +Eos
	W	ORTC	yymmddhhmmss	-	-	-	-	0x0	Write RTC	A:F:ORTC:OK+Eos
	W	OCPS	-	-	-	-	-	0x0	Entrance instruction of calibration	A: F: OCPS: OK+Eos
	W	OCP	Z (zero) M(middle) F (full scale point)	Standard pressure of calibration point	-	-	-	0x0	Input the standard pressure value and calibration points, for calibration	A: F: OCP: OK+Eos
	W	OCPOK	1(save) 0(unsaved)	-	-	-	-	0x0	Quit the pressure calibration process	A: F: OCPOK: OK+Eos
	W	ALARM	High limit	lower limit	Pressure unit	-	-	0x0	Set the alarm limit	A: F: ALARM: OK+Eos
	R	ALARM	-	-	-	-	-	0x0	Read alarm limit	A: F: ALARM: high limit: lower limit : pressure unit+Eos
	W	MRATE	D0	D1	-	-	-	0x0	Set measure D1 times/ D0 second	A: F: MRATE: OK+Eos
	R	MRATE	-	-	-	-	-	0x0	Read the measured times per second	A: F: MRATE: seconds: times+Eos
	W	ODIAL	0(%) 1(swing) 2(alarm)	-	-	-	-	0x0	Set the work mode on the analog dial	A: F: ODIAL: OK+Eos
	W	ORPP	-	-	-	-	-	0x0	Software Reset	A: F: ORPP: OK+Eos

### 3. Pressure units abbreviations

<b>Shortening</b>	KGF	INH <sub>2</sub> O	H <sub>2</sub> O	INHg	Hg	PSI	MBAR	BAR	PA	KPA	MPA	C
<b>Standard</b>	kgf/cm <sup>2</sup>	inH <sub>2</sub> O	mmH <sub>2</sub> O	inHg	mmHg	psi	mbar	bar	Pa	kPa	MPa	customized units

### 4. Pressure units code

The data read by OUIF are algorithms(binary scale), check the selected pressure units after the hexadecimal date is changed.

2 bytes. The selectable pressure code is represented by 2 bytes. 1 (this unit is available), 0 (This unit is unavailable).

kgf/cm <sup>2</sup>	inH <sub>2</sub> O	mmH <sub>2</sub> O	inHg	mmHg	psi	mbar	bar	Pa	kPa	MPa	C
---------------------	--------------------	--------------------	------	------	-----	------	-----	----	-----	-----	---

MSB-10

LSB-0

### 5. Data automatically transmit format

Total data length is 16 bytes, plus an end symbol after the data. Example: \*P 0.0364 MPA.



## **Additel Corporation**

2900 Saturn Street #B

Brea, CA 92821, USA

Phone: 714-998-6899

Email: [service@additel.com](mailto:service@additel.com)

website: [www.additel.com](http://www.additel.com)